



EUROPEAN SPECIFICATION for SPRAYED CONCRETE

EFNARC was founded in March 1989 by five national trade associations representing producers and applicators of specialist building products. Membership has since been widened to include major European companies who have no national body or institution to represent their interests. EFNARC provides a common voice for the industry to make known its comments and views to the European Commission, CEN Technical Committees and other groups dealing with European Harmonisation of Specifications and Standards in sprayed concrete, flooring and protection and repair of concrete structures. EFNARC has specialist Technical Committees dealing with sprayed concrete and flooring.

The Sprayed Concrete Technical Committee was formed in early 1991 and subsequently produced a Final Draft of this document in 1993. Over 1,000 copies have been circulated and it has been widely used as a reference document by specifiers, contractors and material suppliers in many European countries and beyond such as USA, Australia, the Far East, the Middle East and South Africa. It was also adopted by the European Working Group CEN/TC104/WG10 as one of its main documents to produce European Standard on Sprayed Concrete in 1994; and CEN/TC104/SC3 used Appendix 1 on Admixtures as the basis for the production of the European Standard for Sprayed Concrete Admixtures. This new edition takes account of comments made by users of the document during this time.

Bayhass El-Jazairi
President

Acknowledgements

EFNARC wishes to gratefully acknowledge all the contributions and comments made by the users to the 1993 Final draft and to the extensive work undertaken by the members of its Technical Committee. EFNARC wishes to acknowledge with thanks the work undertaken by Simon Austin, Loughborough University in the preparation of this Edition of the Specification.

Although care has been taken to ensure, to the best of our knowledge that all data and information contained herein is accurate to the extent that it relates to either matters of fact or accepted practice or matters of opinion at the time of publication, EFNARC assumes no responsibility for any errors in or misrepresentation of such data and/or information or any loss or damage arising from or related to its use.

All rights reserved. No part of this publication may be reproduced, stored in a retrieval system or transmitted, in any form or by any means, electronic, mechanical, recording or otherwise, without prior permission of EFNARC.

CONTENTS

1.	SCOPE	1
2.	REFERENCED STANDARDS.....	1
3.	DEFINITIONS	1
4.	CONSTITUENT MATERIALS	2
4.1	Cements.....	2
4.2	Aggregates	2
4.3	Mixing water	2
4.4	Steel reinforcement.....	2
4.5	Fibres.....	2
4.6	Admixtures	2
4.7	Additions	3
4.8	Curing agents.....	3
5.	REQUIREMENTS FOR CONCRETE COMPOSITION.....	3
5.1	General	3
5.2	Cement	3
5.3	Additions	3
5.4	Aggregates	4
5.5	Admixtures	4
5.6	Fibres.....	4
5.7	Consistence.....	5
5.8	Working temperature	5
6.	REQUIREMENTS FOR DURABILITY.....	5
6.1	General	5
6.2	Chloride content	5
6.3	Alkali content	5
6.4	Requirements related to environment conditions	5
7.	MIX COMPOSITION.....	5
7.1	General	5
7.2	Designed mixes	5
7.3	Prescribed mixes	6
7.4	Combined mix design	6
8.	EXECUTION OF SPRAYING	6
8.1	Preparatory work	6
8.2	Execution of spraying	6
8.3	Curing	7
8.4	Protection against frost.....	7
9.	REQUIREMENTS FOR FINAL PRODUCT.....	7
9.1	Compressive strength	7
9.2	Flexural strength	8
9.3	Toughness properties.....	8
9.4	Modulus of elasticity.....	10
9.5	Bond strength	10
9.6	Fibre content.....	10
9.7	Permeability.....	10
9.8	Frost resistance.....	10

10.	TEST METHODS.....	11
10.1	Test panels.....	11
10.2	Compressive strength and density.....	11
10.3	Flexural strength and residual strength.....	12
10.4	Energy absorption class (plate test).....	14
10.5	Modulus of elasticity.....	15
10.6	Bond strength.....	16
10.7	Permeability.....	16
10.8	Frost resistance.....	16
10.9	Determination of fibre content	16
11.	QUALITY CONTROL.....	17
11.1	General	17
11.2	Preconstruction tests.....	18
11.3	Quality control.....	18
12.	HEALTH AND SAFETY.....	20

APPENDIX 1 - Admixtures for Sprayed Concrete: Definitions, Specifications, Requirements, Reference Concrete Mixes and Test Methods..... 21

	CONTENTS	22
1.	SCOPE	23
2.	REFERENCES	23
3.	DEFINITIONS.....	24
4.	REQUIREMENTS.....	24
5.	REFERENCE SPRAYED CONCRETE	26
6.	TESTING PROCEDURE.....	28
7.	DECLARATION OF CONFORMITY	30
8.	MARKING AND LABELLING	30

1. SCOPE

This specification deals with concrete or mortar which is pneumatically placed onto a surface. The term sprayed concrete covers both wet and dry processes.

Sprayed concrete can be categorised according to application as follows:

- a. Structural
- b. Supporting rock and excavation
- c. Short-term support
- d. Surface improvement
- e. Repair

2. REFERENCED STANDARDS

The following standards are referred to in the specification. However, any subsequently published or revised European standard (EN) should always take preference over standards referred to herein. The hierarchy of authority is EN standard, ISO standard, National standard.

EN 197	Cement; Composition, specifications and conformity criteria
EN 206	Concrete - Performance, production, placing and compliance criteria
EN 450	Fly ash for concrete - Definitions, requirements and quality control
EN 934-2	Admixtures for concrete, mortars and grouts - Part 2: Concrete admixtures - definition, specification and conformity criteria
EN 934-5	Admixtures for concrete, mortars and grouts - Part 5: Sprayed concrete admixtures - definition, specification and conformity criteria
EN 934-6	Admixtures for concrete, mortars and grouts - Part 6: Sampling, quality control, evaluation of conformity and marking and labelling
EN 1008	Mixing water for concrete
EN 1504	Products and systems for the protection and repair of concrete structures
EN 1542	Products and systems for the protection and repair of concrete structures - Test methods - Measurement of bond strength by pull-off
EN 4012	Testing concrete - Determination of compressive strength of test specimens
EN 6275	Testing concrete - Determination of density of hardened concrete
EN 6784	Testing concrete - Determination of static modulus of elasticity in compression
EN 7031	Testing concrete - Determination of the depth of penetration of water under pressure
EN 7034	Testing concrete - Cored specimens - Taking, examining and testing in compression
EN 10080	Steels for Reinforcement of Concrete. Weldable, ribbed reinforcing steel B 500. Technically delivery conditions for bars, coils and welded fabric
EN 10138	Pre-Stressing steel, Part 1 - Part 5
ASTM C 666	Test Method for Resistance of Concrete to Rapid Freezing and Thawing
ASTM C 672	Scaling Resistance of Concrete Surfaces Exposed to Deicing Chemicals
ASTM A 820	Specification for Steel Fibres for Fibres-Reinforced Concrete
SS 137244	Betongprovning - Hårdnad betong - Frostresistens

Note: Some of these EN standards are in preparation.

3. DEFINITIONS

Sprayed concrete is a mixture of cement, aggregate and water projected pneumatically from a nozzle into place to produce a dense homogeneous mass. Sprayed concrete normally incorporates admixtures and may also include additions or fibres or a combination of these.

Wet process is a technique in which cement, aggregate and water are batched and mixed together prior to being fed into a purpose-made machine and conveyed through a pipeline to a nozzle where the mixture is pneumatically and continuously projected into place. The mixture normally incorporates admixtures and may also include additions or fibres or a combination of these.

Dry process is a technique in which cement and aggregate are batched, mixed and fed into a purpose-made machine wherein the mixture is pressurised, metered into a compressed air stream and conveyed

through hoses or pipes to a nozzle where water is introduced as a spray to wet the mixture which is then projected continuously into place. The mixture may also incorporate admixtures or additions or fibres or a combination of these.

Layer is a term used for a discrete thickness of sprayed concrete, built up from a number of passes of the nozzle and allowed to set

Rebound losses are part of the overall production losses and consist of material which, having been sprayed through the nozzle and struck the surface, does not adhere.

Nozzle is the equipment through which the mix is discharged; it consists of a pipe with a mixing unit into which constituents are injected. With the dry process, water and any liquid admixtures are added; with the wet process, liquid admixtures and pressurised air are added.

Binder is the total amount of cement and cementitious addition in the sprayed concrete.

Fibre reinforced sprayed concrete is primarily made of cements, aggregates and discrete reinforcing fibres. Fibres suitable for reinforcing concrete and mortar have been produced from steel and organic polymers. Glass and carbon fibres have also been used in mortar matrices.

4. CONSTITUENT MATERIALS

Materials shall fulfil the general requirements given below. Specific requirements for materials for sprayed concrete are given in Section 5.

4.1 Cements

Cements shall comply with the requirements of EN197 or alternatively with the national standards or regulations valid in the place of use of the sprayed concrete. Only cement with established suitability for sprayed concrete applications shall be used.

4.2 Aggregates

Aggregates shall comply with the requirements of the national standards and regulations valid in the place of use of the sprayed concrete and shall be appropriate to the requirements of the application.

4.3 Mixing water

Water for mixing shall comply with the requirements of EN 1008 or the national standards and regulations.

4.4 Steel reinforcement

Reinforcement shall comply with the requirements of EN 10080 for reinforcing steel and EN 10138 for prestressing steel or with the national standards or regulations valid in the place of use.

4.5 Fibres

4.5.1 Steel fibres

Steel fibres shall comply with the requirements given in ASTM A 820 or similar national regulations.

4.5.2 Synthetic fibres

Synthetic fibres shall be in accordance with national standards or regulations valid in the place of use of the sprayed concrete.

4.6 Admixtures

Admixtures for concrete and sprayed concrete shall comply with the requirements of EN 934-2 and EN 934-5 respectively, and sprayed concrete admixtures with Appendix 1, or with the national standards or regulations valid in the place of use. For their sampling, evaluation of conformity, marking and labelling they shall comply with EN 934-6.

4.7 Additions

4.7.1 General

The most commonly used additions in sprayed concrete are fly ash, ground granulated blastfurnace slag and silica fume. These additions shall comply with the relevant European standards or national standards or regulations valid in the place of use of the sprayed concrete.

4.7.2 Fly Ash (Pulverised fuel ash)

Fly ash is a finely divided inorganic Pozzolan material which can be added to concrete to improve or achieve certain properties in the plastic and/or hardened state.

Fly ash used in sprayed concrete shall comply with EN 450 or with the national standards or regulations valid in the place of use.

4.7.3 Ground Granulated Blastfurnace Slag (GGBS)

GGBS is a fine granular latent hydraulic binding material which can be added to concrete in order to improve or achieve certain properties in the plastic and/or hardened state.

GGBS used in sprayed concrete shall comply with national standards and regulations valid in the place of use of the sprayed concrete.

4.7.4 Silica Fume

Silica fume is a finely divided, highly active inorganic pozzolan material which can be added to concrete to improve or achieve certain properties.

Silica fume used in sprayed concrete shall comply with the European standards or national standards or regulations valid in the place of use of the sprayed concrete. Where such standards and/or regulations do not exist the use of silica fume shall comply with the recommendations of the suppliers.

4.7.5 Pigments

The inclusion of pigment shall comply with European standards or national standards or regulations valid in the place of use of the sprayed concrete.

4.8 Curing agents

The curing agents shall be in accordance with the European standards or national standards or regulations valid in the place of use of the sprayed concrete.

5. REQUIREMENTS FOR CONCRETE COMPOSITION

5.1 General

The concrete mix including cement, aggregates, water and any admixtures, additions or fibres shall be selected to satisfy all the performance criteria for the fresh and hardened concrete.

5.2 Cement

The minimum cement content for a particular environmental condition shall be as required by Section 6.4 and EN 206.

5.3 Additions

The contractor is allowed to add an approved cementitious material as described in Section 4.7 within the limits given in Table 5.3.1 unless otherwise directed by the client or the client's representative. Addition of pigment should comply with the requirements of EN 206.

Cement additions may also be specified as a cement replacement, but must not exceed the relative proportions given by Table 5.3.1.

Table 5.3.1: Maximum level of additions (by weight)

Cementitious material	Maximum addition
Silica Fume	15% of Portland cement
Fly Ash	30% of Portland cement
	15% of Portland/Fly Ash cement
	20% of Portland blastfurnace slag cement
GGBS	30% of Portland cement

5.4 Aggregates

The gradation curve should normally be in the shaded area given in Figure 5.4.1, the finer region being more suitable for dry mixes (although a high proportion of particles < 0.25 mm can lead to dust problems without adequate pre-dampening). It is the responsibility of the contractor to choose the most suitable grading for the process and materials available.

For dry mixes the natural moisture content in the aggregate must be as constant as possible and should not be more than 6%.

Figure 5.4.1: Recommended aggregate gradation zone

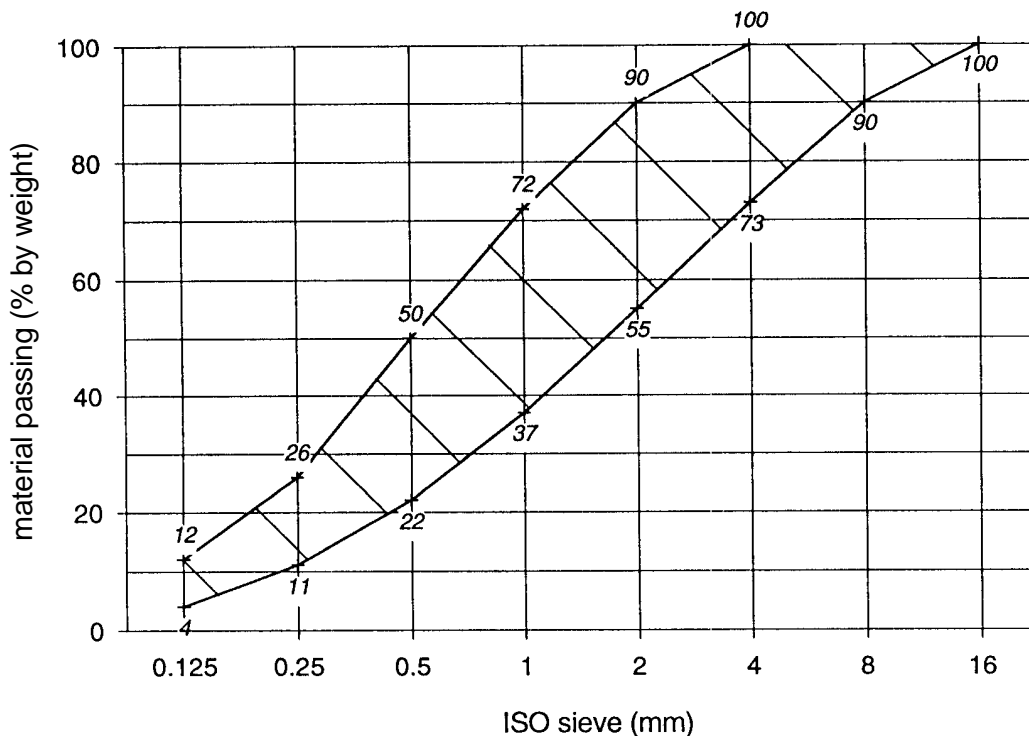

5.5 Admixtures

Admixtures shall comply with EN 934-5 or Appendix 1 of this specification (for sprayed concrete) or EN 934-2 (for concrete). Other admixtures shall be permitted provided that they comply with the general requirements stated in Table 1 of these standards and Table 1 of Appendix 1. Full account should be taken of their effect on the finished sprayed concrete and there should be sufficient data about their suitability, including previous experience with such materials. Records concerning details of the performance of such admixtures shall be maintained.

5.6 Fibres

Fibre reinforcement shall be specified preferably by the fibre reinforced sprayed concrete's performance requirements (or alternatively by the type and amount in the sprayed concrete). Different fibre types may require different amounts to reach the same performance levels.

The length of the steel fibres shall not exceed 0.7 of the internal diameter of the pipes or hoses used unless a test has proven that longer fibres can be sprayed without blockage.

Fibres shall be stored in accordance with the suppliers recommendations.

5.7 Consistence

The concrete consistence required for wet spraying depends on the type of conveyance and the application procedure. For a given cement content and w/c ratio the consistence can be adjusted by admixtures added at the mixing plant or on site.

5.8 Working temperature

The temperature of the mix before placing shall not be below 5°C and shall not exceed 35°C unless special provisions are made. Spraying shall not be undertaken when ambient temperature is below 5°C.

6. REQUIREMENTS FOR DURABILITY

6.1 General

To produce a durable concrete, which protects the reinforcing steel against corrosion and withstands satisfactorily the environmental and working conditions to which it is exposed during its lifetime, the following factors shall be taken into consideration:

- a) choice of suitable constituents, containing no harmful components, or those which may interact unfavourably;
- b) choice a concrete composition that satisfies all specified performance criteria.

6.2 Chloride content

The chloride content of the in situ sprayed concrete shall not exceed the values that are specified in ENV 206 Section 5.5.

6.3 Alkali content

The alkali content of the aggregate shall comply with the requirements of current National Standards to prevent alkali-silica reaction.

6.4 Requirements related to environmental conditions

The sprayed concrete shall be specified to meet the appropriate environmental exposure classes given in Section 5 of EN 206 and related prescriptive requirements, with the following exceptions:

- (i) the maximum water/cementitious ratio shall not exceed 0.55;
- (ii) the minimum cement content shall be 300 kg/m³
- (iii) frost resistance shall be determined by freeze-thaw testing (see section 9.8) not by minimum air content; and
- (iv) the minimum cover requirements relate to bar and mesh reinforcement but not steel fibres.

7. MIX COMPOSITION

7.1 General

The Designed Mix approach is the preferred method of mix specification for dry process sprayed concrete because it produces a better defined and more consistent end product than the Prescribed Mix approach.

7.2 Designed mixes

The mix shall be designed by the contractor to achieve the specified compressive strength and/or other specified properties (see Section 9), using materials which comply with Section 4.

The concrete specification may also contain additional requirements such as:

- minimum cement content
- maximum water/cement ratio
- flexural strength

- toughness
- early strength
- maximum strength
- permeability
- water absorption
- bond to substrate

7.3 Prescribed mixes

The contractor shall provide, or propose for the approval of the client, a prescribed mix which experience has shown to be suitable for the intended purpose.

The prescribed mix shall be specified by the following data:

- cement type and content
- water/cement ratio and/or consistence
- aggregate/cement ratio
- fibre type and content (in situ)
- type and quantity of aggregate
- type and quantity of admixtures
- type and quantity of additions

It is difficult to prescribe the water content with the dry process but in situ water/cement ratios will typically be in the range 0.35 to 0.50.

7.4 Combined mix design

Where neither the Designed Mix nor Prescribed Mix approach is appropriate, the contractor may be required to produce a mix to a hybrid specification, combining elements of Sections 7.2 and 7.3.

8. EXECUTION OF SPRAYING

8.1 Preparatory work

Before spraying of the concrete can start the following preparatory work shall be done.

For rock support:

- poor and loose rock shall be removed from the surface;
- the rock shall be mapped so the total need for support can be clarified; and
- water leakages shall be drained out, either by drainage channels or shall be blocked by the use of an accelerated cement paste - mortar or by grouting.

For repair of concrete:

- the condition of the structure shall be assessed;
- the causes of deterioration shall be identified and eliminated wherever possible:
- defective and loose substrate (concrete, brick, etc.) shall be removed and the remaining material must provide a sound substrate;
- if concrete substrate is carbonated or penetrated by chlorides, the concrete shall be realkalised or the chlorides removed. If this is not possible the contaminated concrete shall be removed, subject to maintaining structural integrity.

8.2 Execution of spraying

For spraying the following shall be undertaken:

- Pre-wetting shall be carried out unless otherwise specified.
- Big cavities shall be carefully built up before the main application.
- Spraying shall start from the bottom and continue upwards. This is to avoid spraying in rebound losses.
- The nozzle direction shall generally be maintained at 90° to the surface.

- The velocity and spraying distance shall be the optimum for maximum concrete adherence and compaction.

8.3 Curing

Sprayed concrete shall be cured in accordance with the recommendations set out in EN 206 or any other method which has been shown to allow continuous hydration of the cement over the curing period.

Curing agents which impair bond shall not be used where a further layer of sprayed concrete is to be applied. Field tests of the bond between layers shall be carried out prior to commencement of work if any other type of curing agent is used.

If necessary, the curing agent shall be removed by water jetting, grit blasting or a similar process, before application of the next layer.

8.4 Protection against frost

Protection against frost is needed until the sprayed concrete has developed a compressive strength of at least 5 MPa.

9. REQUIREMENTS FOR FINAL PRODUCT

9.1 Compressive strength

The strength grade of sprayed concrete shall be specified in accordance with concrete strength classes C24/30 to C48/60 as specified in EN 206 (see Table 9.1.1).

Table 9.1.1: Compressive strength classes for sprayed concrete (EN 206)

Characteristic strength (MPa)							
STRENGTH CLASS	C24/30	C28/35	C32/40	C36/45	C40/50	C44/55	C48/60
Cylinder	24	28	32	36	40	44	48
Cube	30	35	40	45	50	55	60

To determine that the concrete meets the requirements to compressive strength, the in situ strength requirements given in Table 9.1.2 shall be met, which are based on a 50 mm diameter by 100 mm long core and include a 0.85 reduction factor to allow for effects of insitu curing.

Table 9.1.2: In-situ strength requirements

Minimum compressive strength (MPa)							
STRENGTH CLASS	C24/30	C28/35	C32/40	C36/45	C40/50	C44/55	C48/60
Core	20.5	24	27	30.5	34	37.5	41

The values in Table 9.1.2 are average values from 3 samples at 28 days. No single value shall be below 75% of the required strength.

If applicable, the compressive strength development shall be specified by compressive strength tests at agreed concrete ages. If the influence of the site conditions on the strength development has to be taken into account, special curing conditions for the specimens shall be agreed.

For test methods refer to Section 10: Test Methods.

9.2 Flexural strength

If requirements for flexural strength are specified, the values given in Table 9.2.1 may be used. The flexural strength is mainly dependent on the concrete/mortar matrix (even with fibre reinforcement) and is defined in this specification as the equivalent maximum elastic tensile stress at the first peak load - see Section 10.3.2.

Table 9.2.1: Flexural strength

Minimum flexural strength (MPa)			
STRENGTH CLASS	C24/30	C 36/45	C 44/55
Beam flexural strength	3.4	4.2	4.6

The average flexural strength of three beams shall be equal to, or above, the required class value given in Table 9.2.1. No single beam shall be lower than 75% of the class value. For test method refer to Section 10: Test Methods.

9.3 Toughness

9.3.1 General

The toughness of the material is either specified by residual strength class (from a beam test) or energy absorption class (from a plate test). These will not give values that are comparable.

For testing methods refer to Section 10: Test Methods.

9.3.2 Residual strength class

There are five residual strength classes for sprayed concrete which are defined in Figure 9.3.1 and Table 9.3.1 in terms of the shape of the beam stress/deflection curve. The table defines precisely the four points that define the boundaries between each residual strength class. At least two of the three beams shall maintain a flexural stress on, or above, the required class boundary given in Figure 9.3.1 up to the deflection limit appropriate to the deformation class; e.g. a beam specified for the Normal deformation class must maintain a flexural stress on or above the specified residual strength class boundary between 0.5 and 2.0 mm central deflection. No beam shall have a stress/deflection curve which falls below the next lower class (with the exception of beams specified for class 1).

The purpose of the deformation classes is to give designers flexibility in the choice of deformation required of the sprayed concrete under service conditions. For the purpose of design, the deflection limit for a deformation class can be considered in terms of the equivalent angular rotation or nominal crack width for a beam cracked at midspan (e.g. 1 mm equals 0.25° and 0.67 mm respectively).

Figure 9.3.1: Residual strength classes

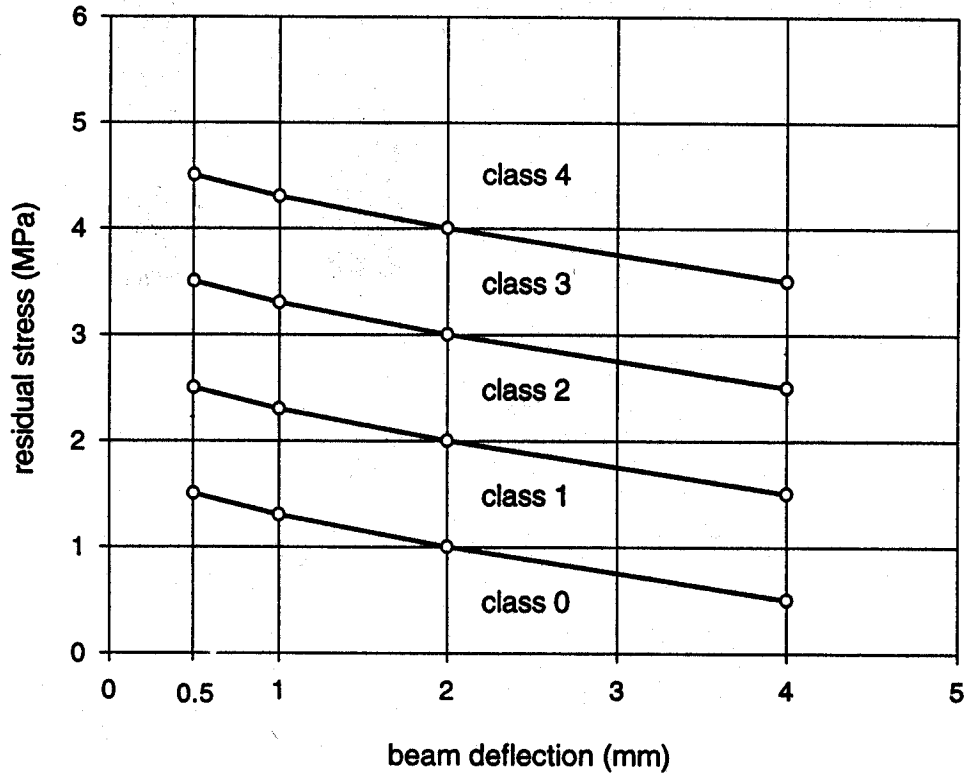

Table 9.3.1: Residual strength class definition points

Deformation class	Beam deflection (mm)	Residual stress (MPa) for strength class			
		1	2	3	4
	0.5	1.5	2.5	3.5	4.5
Low	1	1.3	2.3	3.3	4.3
Normal	2	1.0	2.0	3.0	4.0
High	4	0.5	1.5	2.5	3.5

9.3.3 Energy absorption class

If the energy absorption capacity of the material is specified, the plate test can be performed and the requirements given in Table 9.3.2 may be used.

Table 9.3.2: Energy absorption requirements

Toughness classification	Energy absorption in joule for deflection up to 25mm
a	500
b	700
c	1000

9.4 Modulus of elasticity

When the modulus (in compression, tension or bending) influences the designed capacity or required behaviour of the structure, the in-situ modulus used for the structural design shall be verified. If there are any requirements for thermal expansion or shrinkage this should be specified by the designer.

For test method refer to Section 10: Test Methods.

9.5 Bond strength

If requirements for bond strength are specified the values given in Table 9.5.1 for concrete and rock surfaces may be used. Should the rock afford no bond, even after proper cleaning, no bond strength shall be specified.

For test methods refer to Section 10: Test Methods.

Table 9.5.1: Bond strength: minimum requirements

Type of bond	Minimum bond strength to concrete (MPa)	Minimum bond strength to rock (MPa)
NON STRUCTURAL	0.5	0.1
STRUCTURAL	1.0	0.5

The values given in Table 9.5.1 are average values from 3 samples at 28days. No single value shall be lower than 75% of the required value.

9.6 Fibre content

The content of steel fibre in the sprayed concrete shall be expressed in kg/m^3 after it has been sprayed. The required in-situ fibre content to meet the flexural strength and/or toughness requirements may be determined from testing. A minimum fibre content (either insitu or in test panels) may be agreed for the purposes of quality control, in which case fibre content determinations shall be made (each from the average of three fresh or hardened samples). The average value shall exceed the agreed minimum value and no single value shall be lower than 75% of the minimum value.

For test methods refer to Section 10: Test Methods.

9.7 Permeability

When water-tight sprayed concrete is required the maximum value of penetration in accordance with EN 7031 shall be 50 mm, and the mean average value shall be less than 20 mm.

Alternatively, water-tightness can be determined by measuring water permeability. Sprayed concrete is considered water-tight when the coefficient of water permeability is less than 10^{-12} m/s.

Sprayed concrete in environmental exposure class Highly aggressive is normally used when water-tight concrete is specified.

When applicable, the requirement to gas permeability shall be specified by the client and preconstruction tests shall be carried out.

9.8 Frost resistance

Sprayed concrete subjected to freezing and thawing in moderate water saturation without salt (EN 206 class) shall have no additional requirement for frost resistance testing. Sprayed concrete exposed to more aggressive environments, as specified in EN 206, shall fulfil the requirements for frost resistance as given in:

- SS 137244 or ASTM C 672 for scaling resistance, tested with or without salt water, according to the exposure classification.
- ASTM C666 for freeze-thaw resistance to immersion in water.

10. TEST METHODS

10.1 Test panels and samples

Moulds of steel or other non-water-absorbing rigid material shall be used (a minimum of 4 mm steel sheet or 18 mm plywood). The minimum plan dimensions shall be 600 x 600 mm for hand spraying and 1000 x 1000 mm for robot spraying,. The thickness should be appropriate to the size of test specimens to be cut from the panel, but shall not be less than 100 mm. Appropriate measures shall be taken to avoid entrapment of rebound in the mould (such as using chamfered or slotted sides).

The moulds shall be positioned vertically and sprayed with the same equipment, technique, layer thickness per pass, spraying distance etc. as the actual work. The operator shall also be the same.

The panel shall be protected immediately against moisture loss using the same method to be used in construction. The samples shall be marked for later identification (Mix, location, date, operator).

The panel shall not be moved within 18 hrs of being sprayed. Curing shall continue thereafter for 7 days or until samples are to be extracted.

The test samples shall be cored in accordance with EN 7034 or sawn from the panel, but shall not include material within 125 mm of the edge (with the exception of the ends of beams for flexural/toughness testing).

During transportation to the testing laboratory the panel or sawn samples shall be packed to protect it against mechanical damage and moisture loss.

10.2 Compressive strength and density

Compressive strength tests shall be performed in accordance with EN 4012 on drilled cores taken from the sprayed concrete structure or from sprayed test panels. Their minimum diameter shall be 50mm and the height/diameter ratio shall be in the range 1.0 to 2.0. Test results from cores with height/diameter ratio different from 2.0 shall be converted to equivalent cylinder strengths using the values given in Table 10.2.1.

Table 10.2.1: Conversion factors to equivalent cube and cylinder strengths

Height/diameter ratio of core	Cube factor	Cylinder factor
2.00	1.15	1.00
1.75	1.12	0.97
1.50	1.10	0.95
1.25	1.07	0.93
1.10	1.03	0.89
1.00	1.00	0.87
0.75	0.88	0.76

Alternatively the compressive strength can be determined from cubes cut from sprayed test panels. The minimum dimensions shall be 60 x 60 x 60mm and the samples shall be tested in accordance with EN 4012.

The density shall also be determined by weighing the sample in water and air in accordance with EN 6275 (water displacement method).

Normal testing ages shall be 7 and 28 days.

The test report shall contain:

- test specimen identification
- moisture condition of the test specimen
- test specimen dimensions

- curing conditions and age at test
- maximum load and compressive strength (to nearest 0.5MPa)
- test specimen density (to nearest 10kg/m³)
- appearance of the test specimen (if unusual)
- remarks (if any)

10.3 Flexural strength and residual strength

10.3.1 Testing arrangement

Testing of flexural strength and residual strength shall be carried out on beams with dimensions of 75 x 125 x 600 mm cut from sprayed panels. The beams shall be tested under third point loading on a 450 mm span. The prisms shall be stored in water for a minimum of 3 days after sawing and immediately before testing. The sawn beams shall normally be orientated as shown in Fig 10.3.1. The top of the beam may be orientated as the tension face if required by the designer, although in this case the top surface should not be sawn (to avoid cutting end anchorages of the steel fibres). Testing shall normally be performed at 28 days.

Figure 10.3.1: Cutting and orientation of beams from the sprayed concrete

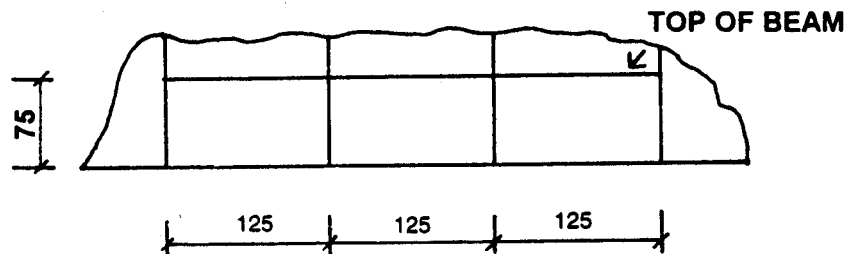

The arrangement for testing shall be as shown in Figure 10.3.2 and shall be so that it is possible to measure bending deflections (i.e. net of support settlement) at the midspan of the beam. The deformation rate of the midspan of the beam shall be 0.25 +/- 0.05 mm per minute until a deflection of 0.5 mm. After this point the rate of deflection can be increased to 1.0 mm/min. The load-deflection curve (deflection at midspan) shall be continuously recorded.

The stiffness of the testing machine shall be such that the test shall be real deflection controlled. The supports and loading points of the testing machine shall all be rounded with a radius of 10 - 20mm. The test shall be finished when a midspan deformation of 4 mm is obtained.

Figure 10.3.2: Flexural testing with third-point loading

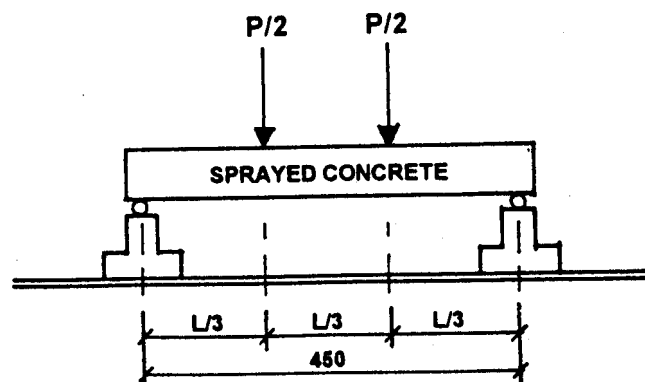

10.3.2 Determination of flexural strength

The flexural strength shall be estimated from the load-deflection curve (Figure 10.3.3) as follows. The initial straight line portion of the curve shall be determined, based on data up to 50% of the peak load, and a line drawn parallel at a horizontal offset of 0.1 mm midspan beam deflection. The flexural strength shall be calculated from the first peak load ($P_{0.1}$) achieved up to and including the point at which the 0.1 mm offset line intercepts the load/deflection curve (see Figure 10.3.3). The flexural strength shall be calculated as an equivalent elastic tensile strength:

$$\text{flexural strength (in MPa)} = P_{0.1} \times L / b \times d^2$$

where $P_{0.1}$ is defined above (in N)

L is the span (450 mm)

b is the actual beam width (nominally 125 mm)

d is the actual beam depth (nominally 75 mm)

Figure 10.3.3: Determination of $P_{0.1}$ load from load/deflection curve

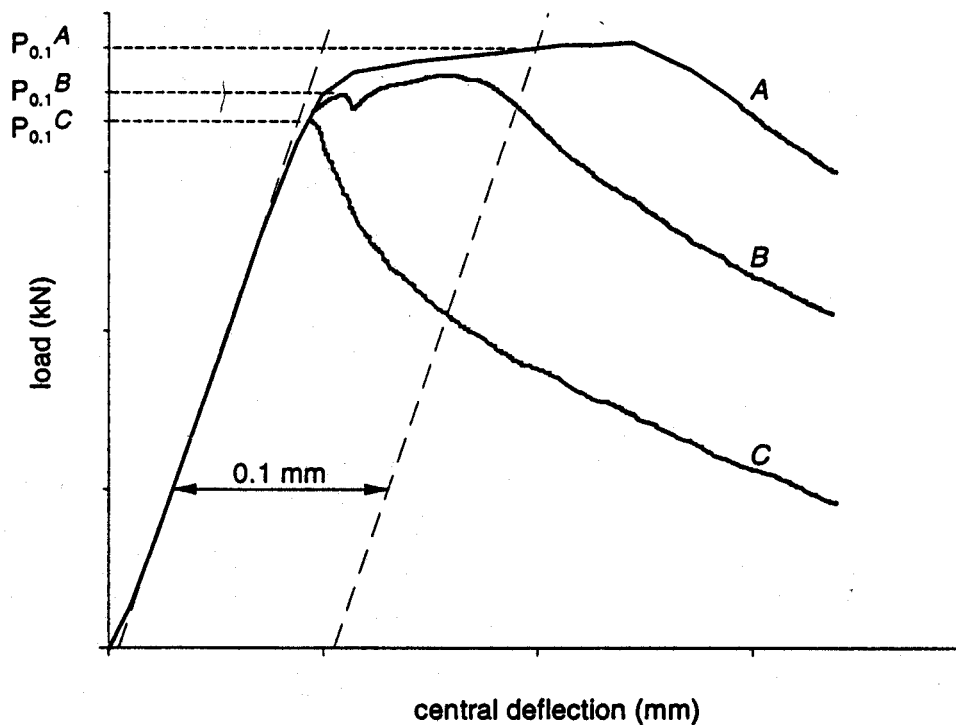

The report shall contain:

- type of the testing machine
- specimen identification
- test specimen dimensions
- curing conditions and age at testing
- rate of deformation
- load-deformation curve including first peak load ($P_{0.1}$)
- calculated flexural strength

10.3.3 Determination of residual strength class

The residual strength class shall be estimated from the load/deflection curve using flexural stress values between 0.5 and 1, 2 or 4 mm depending on the specified deformation class, see Figure 9.3.1 and Table 9.3.1.

It is recommended that each beam is classified by converting the flexural stresses defining the classification boundaries (given in Table 9.3.1) into load values (using the beams actual dimensions) and plotting these (joined by straight lines) on the beam load deflection curve.

The report shall contain:

- type of the testing machine
- specimen identification
- test specimen dimensions
- curing conditions and age at testing
- rate of deformation
- load-deformation curve including flexural stress values for the specified deformation class deflections
- deformation class and residual strength class

10.4 Energy absorption class (plate test)

A test plate of 600 x 600 x 100mm shall be supported on its 4 edges and a centre point load applied through a contact surface of 100 x 100mm (Figure 10.4.1). The rough side shall be on the bottom during the test, i.e. the load is applied opposite to the spraying direction.

The rate of deformation of the midpoint shall be 1.5mm per minute.

Figure 10.4.1: Set-Up for plate test

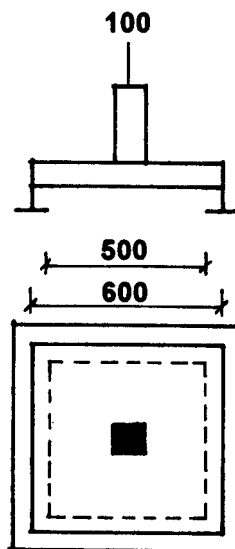

The plate shall be produced from a sprayed panel by levelling the panel at a thickness of 100mm - 0/+10mm, immediately after spraying. The sloped edges of the panel shall be sawn off when the plate is prepared in the laboratory. The prepared plate shall be stored in water for a minimum of 3 days immediately before testing and kept moist during testing.

The load-deformation curve (Figure 10.4.2) shall be recorded and the test shall continue until a deflection of 25mm is achieved at the centre point of the slab.

From the load-deformation curve a second curve shall be drawn giving the absorbed energy as a function of the slab deformation (Figure 10.4.3).

The toughness requirements are given as a specified energy absorption at a certain deflection.

Figure 10.4.2: Example of load-deformation curves

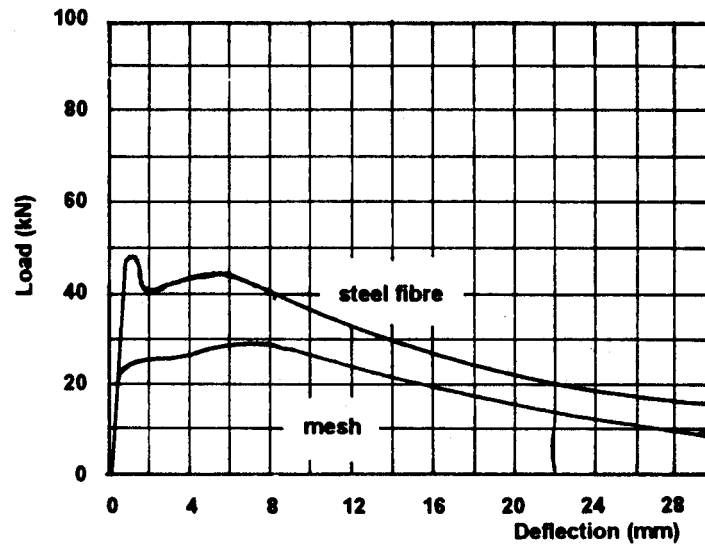
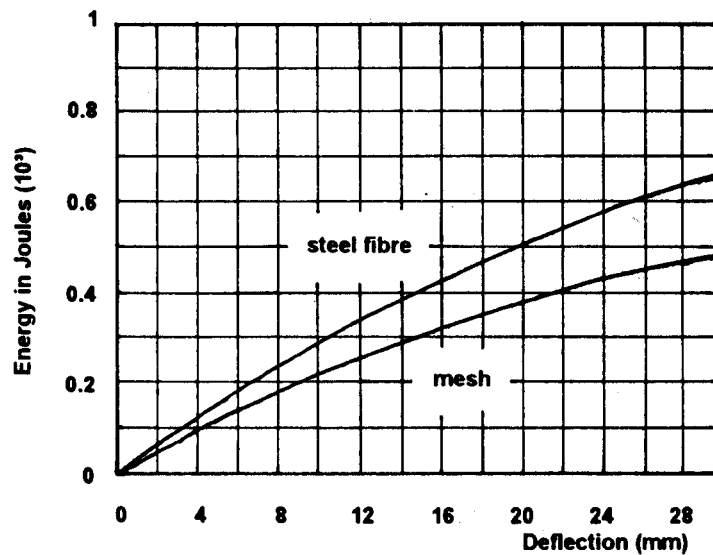

Figure 10.4.3: Example of energy-deformation curves



The report shall contain:

- type and stiffness of the testing machine
- specimen identification
- test specimen dimensions
- curing conditions and age at testing
- rate of deformation
- calculated energy-deformation curves
- first crack load and maximum load
- calculated energy-deformation curves
- energy absorption in Joule for a deflection until 25mm

10.5 Modulus of elasticity

The testing shall be done in accordance with EN 6784.

The report shall contain:

- specimen identification

- test specimen dimensions
- curing conditions and age at testing
- rate of deformation
- load-deformation curve including maximum load
- estimated modulus of elasticity

10.6 Bond strength

The bond strength shall be determined by a partial core test (where appropriate in accordance with EN 1542) or a tensile test, the testing arrangement being similar to those shown in Figure 10.6.1. The rate of loading shall be within 1.0-3.0 MPa per minute. The core diameter shall be within the range 50 to 60 mm. Precautions shall be taken to ensure that the tensile force is applied axially.

The report shall contain:

- specimen identification
- specimen dimension
- age at testing and curing conditions
- rate of loading
- max. load and calculated bond strength
- description of failure plane and mode

Fig. 10.6.1: Examples of core pull and direct tension testing arrangements for bond strength

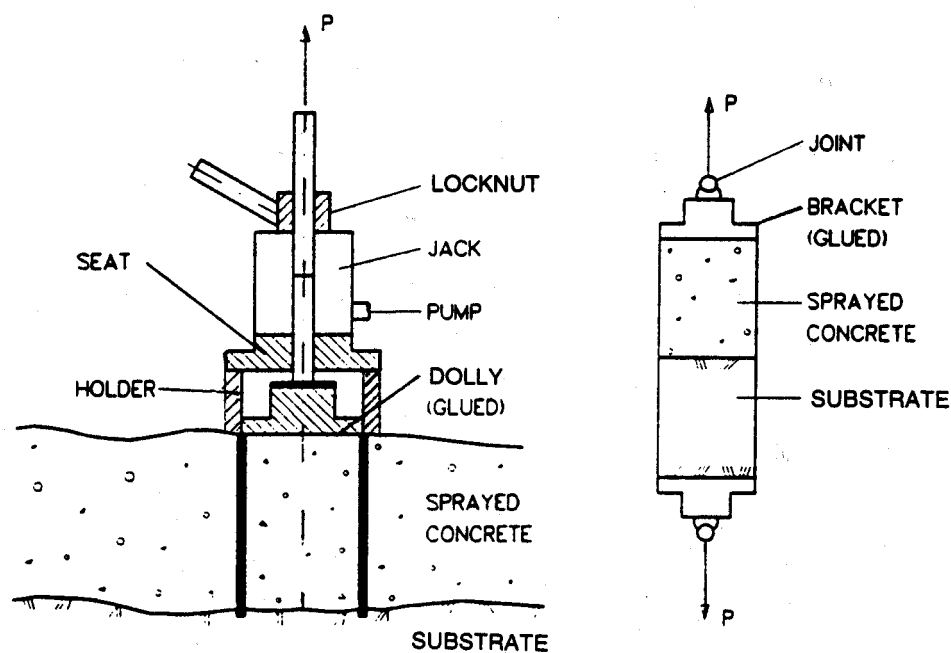

10.7 Permeability

The testing shall be done in accordance with EN 7031.

10.8 Frost resistance

The testing shall be done in accordance with ASTM C672 or SS 137244 for scaling resistance and ASTM C666 for freeze-thaw resistance.

10.9 Determination of the fibre content of sprayed concrete

The fibre content of sprayed concrete can be determined from either fresh or hardened (i.e. before or after set) mortar/concrete samples. Both types of sample are applicable with steel fibres, but only the method for a fresh sample is appropriate with synthetic fibres.

Fresh samples may be extracted from the basic mix, the insitu material or from a test panel. Hardened samples may be cut from the insitu material or from a test panel. It should be

appreciated that the fibre content at each of these locations may be different, due to the spraying process. The most appropriate sample type and location should be used, which will depend on the purpose of the quality control and on the compliance requirements of the specification.

For hardened samples the test may be conducted in as-received, saturated or oven-dried moisture states.

The volume of the sample (before fibre extraction) can be determined by calculation (using actual dimensions) or by water displacement (reference method). The mass of the fibre is then determined by weighing, following extraction of the fibres from the fresh or hardened sample.

10.9.1 Hardened sample (Method A)

Three test cores shall be cut from the insitu material or a test panel. The core diameter shall be 75-150 mm and the core length shall be 75-150 mm (unless the layer thickness is less than 75 mm, in which case the core length should equal the layer thickness).

The volume (V_C) of the cores shall be determined according by calculation (using actual dimensions) or weighing in air and water (method given in EN 6275).

The concrete cores shall be crushed in a compression testing machine, or other suitable device, so that all the fibres in each core can be separated from the concrete. Magnetic fibres can be easily removed by a magnet. The fibres from each core shall be cleaned and then weighed (m_f) to 0.1 g.

10.9.2 Fresh sample (Method B)

Three samples shall be cut from the insitu material or a test panel. The samples shall weigh 1 - 2 kg and must be carefully extracted in one piece.

The volume (V_C) of the samples shall be determined by weighing in air and water (method given in EN 6275).

Wash-out the fibre from each sprayed sample; the sprayed concrete shall be placed in a filter equipment where the cement and other fine materials can be washed out such that the fibre can be separated from the mass. With synthetic fibres the samples may be soaked with alcohol and stirred until the fibres float on the surface. The fibres shall be cleaned, dried and then weighed (m_f) to 0.1 g.

10.9.3 Calculation of fibre content

The fibre content of each sample shall be calculated from the determined fibre mass and sample volume, using the formula:

$$C_f \text{ (kg/m}^3\text{)} = m_f \times 1000 / V_C$$

where C_f is the fibre content (in kg/m³)

m_f is the mass of fibre extracted from the sample (in g)

V_C is the volume of the sample in (cm³)

The report shall contain:

- specimen identification (including location of sample and time of spraying)
- specimen type (hardened or fresh), sizes and volumes
- date and time of testing
- description of fibre type
- calculated fibre content of each sample and the mean value of the three samples

11. QUALITY CONTROL

11.1 General

The production of sprayed concrete shall be subject to quality control procedures. Quality control is defined as a combination of actions and decisions taken in compliance with specifications and checks to ensure that the specified requirements are satisfied.

There are 3 classes of control:

- I Minor control

II Normal control

III Extended control

The choice of control class shall be at the discussion of the designer, based on type of project and consequence of failure.

There are no special requirements for the organisation of the work in control classes I and II. In control class III there shall be a organigram for each project with a quality assurance engineer, dedicated to quality control.

11.2 Preconstruction tests

Composition of the sprayed concrete is determined in the course of preconstruction tests in which the required properties are checked. Examples of properties to be checked:

Fresh concrete:

- water demand, workability, pumpability,
- sprayability/rebound
- slump, density
- dosage of accelerator

Hardened concrete:

- compressive strength at 7 and 28 days
- flexural strength
- residual strength
- fibre content
- bond

The need for such tests is dependent on the type of project and the utilisation of the sprayed concrete, but should always be done in control class III.

11.3 Quality control

11.3.1 *Underground support*

There are two types of control to be specified:

- Production control
- Conformity control

The production control shall be in accordance with EN 206. The conformity control includes control of:

- compressive strength
- flexural strength
- residual strength value
- residual strength
- energy absorption
- bond
- fibre content
- thickness

All tests are to be done on samples taken either from in-situ material or test panels according to Section 10.1.

The frequency of the tests shall be decided by the designer, bearing in mind the function of the sprayed concrete (including structural integrity), its design life, the difficulty of installation, the environmental classification and the consequences of a failure. The values given in Table 11.3.1 may be used as a guide.

Table 11.3.1: Frequency of control testing

TYPE OF CONTROL	MINOR	NORMAL	EXTENDED
Compressive strength	500	250	100
Flexural strength		500	250
Residual strength value		1000	500
Energy absorption		1000	500
Bond		500	250
Fibre content		250	100
Thickness	50	25	10
m ² between tests			

11.3.2 Alignment control

Alignment control is necessary to establish line and grade in sprayed concrete construction and to ensure that proper and uniform material thickness and cover are maintained. Alignment control is accomplished by the use of guide wires, guide strips, depth gages, depth probes, or conventional forms.

Guide wires - Guide wires consist of 1 or 0.8mm high strength steel wire combined with a device, usually a turn-buckle or spring coil, that places the wire under suitable tension. They are the most convenient means to establish line and grade where forms are used for backup purposes. Wires may be used individually to establish corners while several parallel wires in combination may be spaced 0,6 to 0,9m apart to provide screed guides for flat areas.

Guide strips - Guide strips consist of wood lath usually no larger than 25x50mm connected by crosspieces at 0.6 to 0.9m intervals. Guide strips serve as an excellent method of alignment control in both repair and new sprayed concrete construction. Chamfered edges are readily attained using a chamfer strip at the corner of the guide strips.

Depth gauges are small metal or plastic markers attached to or installed perpendicularly in the substrate or backup material at convenient intervals and heights. They provide a preset guide to the thickness of the sprayed concrete and are positioned just below the finish coat of sprayed concrete. They are left in place provided they do not affect the integrity of the application.

Depth probes - Depth probes are used in situations where there is greater latitude in the finish tolerance requirements. They are usually made of steel, 0.67 to 0.78mm, and marked with the specified sprayed concrete thickness. Probes are inserted into the sprayed concrete until the substrate is reached indicating the depth of sprayed concrete. They should only be used if puncture holes can be tolerated in the lining.

Formwork - The use of conventional forms in sprayed concrete work is the exception rather than the rule; however, when they are used, they usually provide automatic alignment control eliminating special devices for line and grade. Nozzle techniques must be carefully controlled to avoid sand pockets and other defects.

Surface finishes - The specific finish requirement shall be detailed as follows:

"As Shot" The sprayed concrete shall be left as from the nozzle.

"Cut & Flash" The sprayed concrete shall be trimmed to true lines and after initial set shall be sprayed with an overwetted flash coat to produce a textured finish.

Trowelled Finishes - Following the treatment detailed in the "Cut & Flash" the material shall be trowelled smooth with one of the following:

- Steel float
- Wooden float
- Brush
- Sponge

Tolerances - The specifier shall detail:

- Maximum +/- tolerance on thickness
- Maximum deviation in 2m straight edge

12. HEALTH AND SAFETY

Application of sprayed concrete should meet all the Health and Safety regulations valid in the place of use.

APPENDIX 1

**Admixtures for Sprayed Concrete; Definitions, Specifications, Requirements,
Reference Concrete Mixes and Test Methods.**

CONTENTS

1.	SCOPE	23
2.	REFERENCES	23
3.	DEFINITIONS	24
3.1	Wet concrete basic mix and dry concrete basic mix	24
3.2	Sprayed concrete admixture	24
3.3	Sprayed concrete accelerating admixture	24
3.4	Thixotropic admixture	24
3.5	Hydration control admixture	24
3.6	Sprayed concrete bond improving admixture	24
3.7	Identification	24
3.8	Performance	24
3.9	Compliance dosage	24
3.10	Recommended range of dosage	24
4.	REQUIREMENTS	24
4.1	General requirements	25
4.2	Performance requirements	25
5.	REFERENCE SPRAYED CONCRETE	26
5.1	Constituent materials	26
5.1.1	Reference cement	26
5.1.2	Reference aggregate	26
5.1.3	Mixing water	27
5.2	Reference sprayed concrete mixes for conformity testing	27
5.3	Mix proportions	27
5.4	Production of reference mix for laboratory testing	28
5.5	Application procedure	28
5.5.1	Equipment	28
5.5.2	Spraying test panels	28
5.5.2.1	Laboratory moulds	28
5.5.2.2	Spraying process of control mix panel	28
5.5.2.3	Spraying process of test mix panel	28
6.	TESTING PROCEDURE	28
6.1	General	28
6.2	Laboratory conditions	29
6.3	Determination of setting time	29
6.3.1	Non-accelerating admixtures	29
6.3.2	Determination of setting time for sprayed concrete containing acceleration admixture	29
6.3.2.1	Constituent materials	29
6.3.2.2	Preparation of reference cement paste	29
6.3.2.3	Test procedure	29
6.3.2.4	Test report	29
6.4	Determination of compressive strength	29
6.5	Tensile bond strength between layers and at interface with substrate	30
7.	DECLARATION OF CONFORMITY	30
7.1	General	30
7.2	Testing	30
7.3	Quality control	30
7.4	Declaration of conformity by the manufacturer	30
8.	MARKING AND LABELLING	30

1. SCOPE

This appendix defines and specifies requirements, reference mixes and test methods for sprayed concrete admixtures.

Provisions governing the practical application of these types of admixtures in the production of sprayed concrete, i.e. requirements concerning composition, mixing, spraying, curing etc. of sprayed concrete, are not part of this specification. For such provisions reference should be made to EFNARC Specification for Sprayed Concrete or any national standards or regulations valid in the place of use.

2. REFERENCES

This appendix incorporates dated or undated references and provisions from other publications. These references, mostly normative, are cited at the appropriate places in the text and the publications are listed hereafter. For dated references, subsequent approved amendments to, or revisions of, any of these publications apply to this appendix. For undated references, the latest edition of the publication referred to applies.

EN 196-3	Methods of testing cement - Part 3: Determination of setting time and soundness
EN 196-6	Methods of testing cement - Part 6: Determination of fineness
EN 197-1	Cement - Composition, specifications and conformity criteria - Part 1: Definitions and compositions
EN 206	Concrete - Performance, production, placing and compliance criteria
EN 480-1	Admixtures for Concrete, Mortar and Grout; Test Methods - Part 1: Reference concrete and reference mortar for testing
EN 480-2	Admixtures for Concrete, Mortar and Grout; Test Methods - Part 2: Determination of the setting time
EN 480-6	Admixtures for Concrete, Mortar and Grout; Test Methods - Part 6: Infrared analysis
EN 480-8	Admixtures for Concrete, Mortar and Grout; Test Methods - Part 8: Determination of the conventional dry material content
EN 480-10	Admixtures for Concrete, Mortar and Grout; Test Methods - Part 10: Determination of water soluble chloride content
EN 934-2	Admixtures for Concrete, Mortar and Grout - Part 2: Concrete Admixtures - Definitions, Specifications and Conformity Criteria
EN 934-6	Admixtures for Concrete, Mortar and Grout - Part: Sampling, quality control and evaluation of conformity
EN 1008	Mixing Water for Concrete - Specification and Tests
EN 1542	Products and Systems for the Protection and Repair of Concrete Structures; Test Methods - Pull off test
EN 4012	Testing concrete - Determination of compressive strength of test specimens
EN 4109	Testing concrete - Determination of consistency - Slump test
EN 7034	Testing concrete - Cored specimens - Taking, examining and testing in compression
EN 9812	Testing concrete - Determination of consistency - Flow test
EN 29000	Quality systems - Model for quality assurance in design, development, production, installation and servicing
ISO 780-1979	Liquid chemical products for industrial use - Determination of density at 20°C
ISO 1158 : 1984	Plastics - Vinyl chloride homopolymers and copolymers - Determination of chlorine
ISO 4316 : 1977	Surface active agents - Determination of pH of aqueous solutions - Potentiometric method
DIN 1048-2: 1991	Testing methods for concrete - Hardened concrete in structures and components
ZTV-SIB 90	"Regulation for bond testing of surfaces and layers" issued by the Federal Ministry of Traffic, Germany (1990)
Note:	Some of these EN standards are in preparation.

3. DEFINITIONS

For the purposes of this appendix, the following definitions apply:

3.1 Wet concrete basic mix and dry concrete basic mix:

- Wet concrete basic mix - wet concrete before the spraying process.
- Dry concrete basic mix - dry concrete mix prior to the addition of water and before the spraying process.

3.2 Sprayed concrete admixture:

Material added to the concrete mix before or during the spraying process to modify the properties of the mix in the fresh or/and hardened state.

3.3 Sprayed concrete accelerating admixture:

Admixture added to the mix before or during the process of spraying to develop very early acceleration of the setting and/or very early hardening of the concrete beyond the limits of conventional concrete accelerating admixtures as defined and specified in EN 934-2.

3.4 Thixotropic admixture:

Admixture added to the mix before or during spraying to develop thickening in the concrete to prevent sagging before the setting of the sprayed concrete.

3.5 Hydration control admixture:

A two-component admixture system. One component is added to the wet concrete basic mix before spraying to inhibit setting and retain consistence or added to a dry concrete basic mix, containing wet aggregate, to inhibit setting. The second component is added at the nozzle to reactivate the setting and hardening process.

3.6 Sprayed concrete bond improving admixture:

Admixture added to the basic mix of the sprayed concrete or at the nozzle to improve the bond between the sprayed concrete layers and/or the tensile bond of the substrate surface of the sprayed concrete.

3.7 Identification:

A procedure to characterise an admixture and to check its batch-to-batch uniformity by measurement of its homogeneity, colour, relative density, dry material content and pH value and recording its infrared adsorption spectrum.

3.8 Performance:

Ability of an admixture to be effective in its intended use without detrimental effects.

3.9 Compliance dosage:

Quantity of admixture, expressed in percentage by mass of hydraulic binder, stated by the manufacturer to meet the requirements of this specification. The compliance dosage shall be within the recommended dosage range.

3.10 Recommended range of dosage:

Dosages between limits, expressed in percentage by mass of hydraulic binder, which the manufacturer recommends for the product, based on experience on site.

NOTE: The use of a recommended dosage does not imply that compliance with the specification will be met over the whole range. Trial tests should be carried out with the materials to be used on site.

4. REQUIREMENTS

All the admixtures defined in this specification shall conform to the general requirements given in Table 1 and the appropriate performance requirements given in Tables 2 to 5. Other types of admixtures meeting the requirement of EN 934-2 shall also be deemed to meet the requirements of this specification.

4.1 General requirements

All the admixtures defined in this specification shall conform to the general requirements given in Table 1 when tested in accordance with the methods given therein. Homogeneity, colour, effective component, relative density, conventional dry material content and pH value constitute the identification requirements as defined in sub-section 3.7.

Table 1: General requirements

Property	Test method	Requirements
Homogeneity ⁽¹⁾	Visual	Homogeneous when used. Segregation shall not exceed the limit stated by the manufacturer.
Colour ⁽¹⁾	Visual	Uniform and similar to the description provided by the manufacturer.
Effective component ⁽¹⁾	EN 480-6 ⁽²⁾	Infrared spectra to show no change with respect to the effective component when compared to reference spectrum provided by the manufacturer.
Relative density ⁽¹⁾	ISO 758	$D \pm 0.03$ if $D > 1.10$; $D \pm 0.02$ if $D < 1.10$; where D is manufacturer's stated value of density
Conventional dry material content ⁽¹⁾	EN 480-8 ⁽³⁾	$0.95 T < X < 1.05 T$ for $T > 20\%$ $0.90 T < X < 1.10 T$ for $T < 20\%$ T is manufacturer's stated value % by mass; X is test result % by mass on dry material content
pH value ^{(1) (4)}	ISO 4316	Manufacturer's stated value ± 1 or within manufacturer's stated range.
Total chlorine ^{(1) (5)}	ISO 1158	Either $< 0.10\%$ by mass or not above the manufacturer's stated value.
Water soluble chloride ⁽¹⁾	EN 480-10	Either $< 0.10\%$ by mass or not above the manufacturer's stated value.
Alkali content (Na ₂ O - equivalent) ⁽¹⁾	EN 480-12	Not above the manufacturer's stated maximum.
Corrosion behaviour	^{(6) (7)}	No corrosion promoting effects on steel embedded in concrete.

⁽¹⁾ Manufacturer's stated value shall be provided in writing to the user on request.

⁽²⁾ In case of the Infrared method not being applicable, the manufacturer shall supply an alternative method.

⁽³⁾ If the method in EN 480-8 is not suitable, the manufacturer shall recommend an alternative test method.

⁽⁴⁾ It is recommended for safety reasons that sprayed concrete admixtures added at the nozzle should have a pH in the range of 4 - 10.

⁽⁵⁾ If there is no significant difference between total chlorine content and water soluble chloride content, only the water soluble chloride content shall be determined in subsequent tests on the admixture involved.

⁽⁶⁾ For testing cement CEM I with C₃A content less than 5% by mass shall be used.

⁽⁷⁾ CEN Standard for test method not yet available.

4.2 Performance requirements

The admixtures in this specification shall conform to the appropriate performance requirements given in Tables 2 to 5.

The tests for performance shall be carried out on a reference sprayed concrete, prepared in accordance with this specification, as required for the test method described in the appropriate sections of this specification. The result of a test on the reference concrete containing the admixture (the test mix) is compared with the result of the same test on a reference concrete or reference mortar without the admixture (the control mix). The dosage of the admixture in the test mix shall be that recommended by the manufacturer.

Table 2: Performance requirements for sprayed concrete accelerating admixture

Property	Test method	Performance required
Setting time	EN 196-3	Initial setting time not more than 10 min., final setting time not more than 60 min., in two out of every three tests.
Compressive strength	EN 7034	At 28 days: test mix \geq 75% of control mix at 28 days At 90 days: test mix \geq test mix at 28 days

Table 3: Performance requirements for thixotropic admixture

Property	Test method	Performance required
Flow	EN 9812	Flow reduction of test mix 50% compared to control mix.
Slump	EN 4109	Slump reduction of test mix 50% compared to control mix.
Compressive strength	EN 7034	Compressive strength of test mix not less than control mix at 28 days.

Table 4: Performance requirements for hydration control admixture

Property	Test method	Performance required
Consistence	Flow: EN 9812 or Slump: EN 4109	Consistence retention of test mix > consistence retention of control mix in accordance with the specification of supplier.
Setting time	EN 480-2	Immediately after preparation of test mix and after consistence retention time, specified by the supplier.
Compressive strength	EN 7034	Compressive strength of test mix not less than control mix, both at 28 days.

Table 5: Performance requirements for sprayed concrete bond improving admixture

Property	Test method	Performance required
Tensile bond strength between layers	EN 1542 DIN 1048-2	Test mix > 125% of control mix, measured on 100 mm diameter cores at 28 days
Tensile bond strength at surface	EN 1542 DIN 1048-2	Test mix > 125% of control mix, measured on 50 mm diameter cores at 28 days
Compressive strength	EN 7034	Compressive strength of test mix not less than control mix, both at 28 days.

5. REFERENCE SPRAYED CONCRETE

This section specifies the constituent materials, the composition and mixing/spraying procedure to produce reference sprayed concrete for testing the efficacy of an admixture that conforms to this specification.

5.1 Constituent materials

5.1.1 Reference cement

The reference sprayed concrete mixes and reference mortars for the performance tests shall be made with CEM 1 cement of strength class 42.5 conforming to EN 197-1. The cement used shall have a C_3A content of 7 to 11% by mass and a specific surface area of 320-400m²/kg determined in accordance with EN 196-6.

5.1.2 Reference aggregate

A natural normal weight aggregate with low water absorption (less than 2% by mass) shall be used. The grading of the aggregate used in the production of reference concrete shall comply with Table 6.

Table 6: Grading of aggregate for reference sprayed concrete mix

SIEVE SIZE (mm)	% PASSING(1)
4.00	100
2.00	75 - 100
1.00	50 - 75
0.50	25 - 50
0.25	7.5 - 20
0.125	<7.5

- (1) The variation in the quantity passing each sieve of the chosen grading for both mixes (control and test mix) shall not exceed ± 2.0 %.

5.1.3 Mixing water

Water for mixing shall comply with the requirements of EN 1008. Distilled or deionised water may be used.

5.2 Reference sprayed concrete mixes for conformity testing

The wet mix system is used for laboratory evaluation of a sprayed concrete admixture. The performance of an admixture is assessed by carrying out tests on a reference sprayed concrete.

The result of a test on the reference sprayed concrete containing an admixture (the test mix) is either given directly or is compared with the same test on a reference sprayed concrete without any admixture (the control mix). The ratio of these two results is expressed as a percentage. The test mix and the control mix shall have the same aggregate/cement ratio and constituent materials shall be from the same delivery.

The composition of sprayed concrete with and without the sprayed concrete admixtures shall correspond to that specified in section 5.1, the fresh concrete being properly sprayed.

The constituents of the mix for testing shall be conditioned to a temperature of $20^{\circ} \pm 2^{\circ}\text{C}$ prior to mixing or alternatively the temperature of the fresh concrete shall be $20^{\circ} \pm 2^{\circ}\text{C}$ immediately after mixing is completed.

5.3 Mix proportions

The mix proportions of the components shall be in accordance with Table 7.

Table 7: Mix proportions of reference sprayed concrete mix¹ for testing sprayed concrete admixtures

MATERIAL	QUANTITY FOR 1m ³
Cement	500kg \pm 5kg
Water	225kg \pm 5kg
Aggregate (to Table 6)	to complete 1m ³

The aggregate addition shall be calculated from the aggregate's relative density. Aggregates shall be used either in an over dry condition, to remove any moisture content variation, or their moisture content shall be determined and the mix proportion corrected accordingly. In case of dispute, oven dry aggregates shall be used.

¹ Additionally a water-reducing plasticising admixture or a high range water-reducing superplasticising admixture may be added to the mix to produce a pumpable consistency of no less than 100 mm slump in accordance to test method ISO 4109.

The water content of liquid concrete admixtures shall be taken into account in the water/cement ratio when determining batch weights.

5.4 Production of reference mix for laboratory testing

The sprayed concrete reference mix shall be produced according to Table 7. The mixing may be performed with a pan mixer or in an integral mixer belonging to the spray equipment.

5.5 Application procedure

5.5.1 Equipment

The wet process machine² shall have an output capacity of 0.5m³/h. The dispensing unit for the admixture shall have an accuracy of $\pm 0.5\%$ of the recommended dosage. The admixture shall be incorporated as recommended by the manufacturer.

5.5.2 Spraying test panels

Before spraying the test panels the spraying process shall be optimised to ensure a continuous output. The output capacity shall be determined. The reference concrete panel and the panel of concrete with the admixture shall be sprayed using the same mix.

5.5.2.1 Laboratory moulds

Moulds shall have approximate dimension of 500x500x120mm deep and shall be of rigid construction.

5.5.2.2 Spraying process of control mix panel

The mould shall be positioned horizontally on the ground. The mould to nozzle distance shall be between 0.5 and 1m and perpendicular to the mould base. The spraying time shall be recorded. The control mix may contain admixture, in which case, the consumption of the admixture shall be determined by weighing to an accuracy of $\pm 5\%$. The admixture dosage shall be calculated using the determined output and shall not exceed the maximum recommended dosage. After completion of spraying, the sprayed concrete panel shall be sprayed with a curing membrane and covered with a plastic sheet to ensure proper curing.

5.5.2.3 Spraying process of test mix panel

The mould shall be positioned vertically. The mould nozzle distance shall be between 0.5 and 1m and perpendicular to the mould base. The spraying time shall be recorded and the consumption of the accelerator shall be determined by weighing to an accuracy of $\pm 0.5\%$. The admixture dosage shall be calculated using the determined output and shall not exceed the maximum recommended dosage. After completion of spraying, the sprayed concrete panel shall be sprayed with a curing membrane and covered with a plastic sheet to ensure proper curing.

6. TESTING PROCEDURE

6.1 General

All tests shall be carried out on both the control mix (reference mix without admixture) and test mix (reference mix with admixture).

6.2 Laboratory conditions

Unless otherwise stated the laboratory conditions for samples and testing shall be:

Temperature	$20 \pm 2^{\circ}\text{C}$
Relative humidity	$> 65 \%$

² Pump type - mono/screw pump with stepless adjustable output.

6.3 Determination of setting time

6.3.1 *Non-accelerating admixtures*

The setting time of all sprayed concrete containing admixtures, with the exception of sprayed concrete containing accelerating admixtures, shall comply with EN 480-2 for the test method using reference mortar. The constituent materials, mix proportions and mixing procedure of the reference mortar shall comply with EN 480-1.

6.3.2 *Determination of setting time for sprayed concrete containing accelerating admixture*

Reference cement pastes with admixture (test mix) and without admixture (control mix) shall be used. The test (Vicat apparatus) for setting time shall comply with EN 196-3. The test of setting time is not a comparative test between control mix and test mix. Information of setting time for both control and test mix is essential.

Note: This specification describes the reference procedure; it allows the use of alternative apparatus, provided that they do not affect the results. In the event of a dispute, only the reference procedure described in this appendix shall be used.

6.3.2.1 *Constituent materials*

Constituent materials shall comply with sub-clauses 5.1.1 to 5.1.3 of this specification.

6.3.2.2 *Preparation of reference cement paste*

Cement, water, admixture and apparatus used shall be stored under laboratory conditions as specified in sub-clause 6.2 for at least 12 hours before the cement paste is prepared.

Prepare the cement paste by mixing, in a suitable container, 300 ± 15 g of reference cement with 105 ± 5 g of water to a homogeneous paste. Add to the paste the quantity of the admixture specified by the supplier, mix quickly and thoroughly and place in the mould of the Vicat apparatus. Mixing and filling of the mould shall be within 15-30 seconds, without undue segregation or vibration.

6.3.2.3 *Test procedure*

The testing procedure and the determination of the initial and final setting time shall comply with EN 196-3.

6.3.2.4 *Test report*

- Type of test equipment
- Constituent materials
- Temperature at which the test is carried out to the nearest 1°C
- Initial and final setting times for the control and test mix expressed in minutes

6.4 Determination of compressive strength

The compressive strength shall be determined according to EN 4012. Cores for compressive strength measurement shall be taken from the control and the test concrete panels after 1, 7, 28 and 90 days. The cores shall be 100 mm in diameter and 100 mm in height respectively.

Core drilling shall be performed 2 hours before testing unless the time of the core drilling and curing of core samples are otherwise specified. For each compressive strength measurement an average of 5 test results shall be used.

6.5 Tensile bond strength between layers and at interface with substrate

The preparation and procedure for tensile bond strength shall comply with the relevant specification of EN 1542 or ZTV-SIB 90. (The latter includes specification for the preparation of the sprayed concrete for this test).

7. DECLARATION OF CONFORMITY

7.1 General

This procedure is intended for the approval of a sprayed concrete admixture.

7.2 Testing

Testing has to be carried out by the manufacturer to prove the conformity of sprayed concrete admixture requirements in order that it fulfils all the general requirements given in Table 1 and the appropriate performance requirements given in Tables 2 to 5.

7.3 Quality Control

The manufacturer shall operate a quality control system in accordance with EN29000 at each facility where admixtures are produced.

Compliance with this requirement shall be verified by an approved certification body which shall issue a certificate to each production facility where procedures have been verified.

After initial certification, an audit of each production facility shall be carried out by the approved certification body not less than once per year. If any non-compliance with the requirements of EN29000 is found, the certification body shall either:

(i) require correction of non-compliance within a stated time which, if not carried out, shall result in withdrawal of the certificate

or

(ii) immediately withdraw the certificate.

7.4 Declaration of Conformity by the Manufacturer

Provided the requirements of 7.2 and 7.3 have been fulfilled, a declaration of conformity with this specification shall be issued by the manufacturer for each admixture which satisfies the appropriate requirements in this specification.

A new declaration of conformity shall be issued following any change in formulation or in constituent materials which results in a change of the characteristics of the product.

The time between conformity tests shall be not more than 5 years.

8. MARKING AND LABELLING

When admixtures are supplied in containers, they shall be clearly marked with the following information. When the material is supplied in a bulk container at the point of delivery, the same information shall be provided in writing at the time of delivery as follows:

- a) the name, trade mark or other means of identification of the manufacturer
- b) the trade designation of the product, i.e. brand name, reference number and/or letter and batch number
- c) type of admixture
- d) the chloride ion content, expressed as a percentage by mass of total admixture
- e) alkali content expressed as Na₂O equivalent percent by mass of admixture
- f) a summary of storage requirements including any special requirements on storage life shall be clearly marked, e.g. This admixture shall not be taken to comply with this specification after "Best Use Before (date)"
- g) instructions for use and any necessary safety precautions
- h) the manufacturer's recommended range of dosage
- i) the number, date and relevant section of this specification.

EFNARC

Association House, 99 West Street, Farnham, Surrey GU9 7EN, UK

Tel: +44 (0)1252 739147 Fax: +44 (0)1252 739140

www.efnarc.org
